



SMART Board® MX | MX Pro

series interactive displays

User guide

SMART Board MX (V4) series | SMART Board MX Pro (V4) series
SMART Board MX (V3) series | SMART Board MX Pro (V3) series
SMART Board MX (V2-C) series | SMART Board MX Pro (V2-C) series
SMART Board MX (V2) series | SMART Board MX Pro (V2) series
SMART Board MX series
(See page 13 for specific models.)

IDX55-4 | IDX65-4 | IDX75-4 | IDX86-4 | IDX55-3 | IDX65-3 | IDX75-3 | IDX86-3 | IDX55-2 | IDX65-2 | IDX75-2 | IDX86-2 | IDX65-1 | IDX75-1 | IDX86-1



Was this document helpful?
smarttech.com/docfeedback/171554

SMART®



Learn more

This guide and other resources for SMART Board MX and MX Pro series interactive displays are available in the Support section of the SMART website (smarttech.com/support). Scan this QR code to view these resources on your mobile device.



ENERGY STAR is the government-backed symbol for energy efficiency, providing simple, credible, and unbiased information that consumers and businesses rely on to make well-informed decisions. ENERGY STAR-certified products are the simple choice for energy efficiency, making it easy for consumers and businesses to make purchases that save them money and protect the environment. The U.S. EPA ensures that each product that earns the label is independently certified to deliver the quality, performance, and savings that users have come to expect.

As shipped, your display delivers ENERGY STAR performance and savings. However, changing some settings may increase energy consumption beyond the limits required for ENERGY STAR certification. For example, increased brightness and contrast will increase power consumption.

Please consider the environment when you choose non-ENERGY STAR settings.

License



The terms HDMI, HDMI High-Definition Multimedia Interface, HDMI trade dress and the HDMI Logos are trademarks or registered trademarks of HDMI Licensing Administrator, Inc.

Trademark notice

SMART Board, SMART Notebook, SMART TeamWorks, SMART Meeting Pro, SMART Ink, SMART lab, Lumio, Object Awareness, smarttech, the SMART logo and all SMART taglines are trademarks or registered trademarks of SMART Technologies ULC in the U.S. and/or other countries. Android, Chrome, Chromebook, Google Cast, Google Drive, and Google Play are trademarks of Google Inc. Microsoft, Windows, and OneDrive are either registered trademarks or trademarks of Microsoft Corporation in the United States and/or other countries. Mac, macOS, iOS, and AirPlay are trademarks of Apple Inc., registered in the U.S. and other countries. Intel and Core are trademarks of Intel Corporation in the U.S. and/or other countries. All other third-party product and company names may be trademarks of their respective owners.

Copyright notice

© 2019–2023 SMART Technologies ULC. All rights reserved. No part of this publication may be reproduced, transmitted, transcribed, stored in a retrieval system or translated into any language in any form by any means without the prior written consent of SMART Technologies ULC. Information in this manual is subject to change without notice and does not represent a commitment on the part of SMART.

This product and/or use thereof is covered by one or more of the following U.S. patents:

www.smarttech.com/patents

February 28, 2023

Important information

Note

Refer to the *SMART Board MX and MX Pro series interactive displays installation and maintenance guide* (smarttech.com/kb/171555) for important information about installing and maintaining the display.

Warning

- Do not open or disassemble the display. You risk electrical shock from the high voltage inside the casing. Opening the casing also voids the warranty.
- Do not stand (or allow children to stand) on a chair to touch the surface of the display.
- To reduce the risk of fire or electric shock, do not expose the display to rain or moisture.
- Do not insert objects inside the cabinet ventilation holes, because they could touch dangerous voltage points and cause electric shock, fire, or product damage which may not be covered by the warranty.
- Do not place heavy objects on the power cable. Damage to the cable could cause shock, fire, or product damage which may not be covered by the warranty.
- If the glass is broken, do not touch the liquid crystal. To prevent injury, handle glass fragments with care when disposing of them.
- Disconnect all of the display's power cables from the wall outlet and seek assistance from qualified service personnel if any of the following occur:
 - The power cable or plug is damaged
 - Liquid is spilled into the display
 - Objects fall into the display
 - The display is dropped
 - Structural damage, such as cracking, occurs
 - The display behaves unexpectedly when you follow operating instructions
- Before inserting or removing an OPS from the display, turn off the display using the switch at the back of the display. See [Open Pluggable Slot computer \(OPS\) disclaimer](#) for more information.

Contents

- Important information 3**
- Chapter 1 Welcome 6**
 - About this guide 6
 - About the display's features and components 7
 - Identifying your specific model 13
 - Accessories 14
 - More information 15
- Chapter 2 Using basic features 16**
 - Waking up the display and putting it back to sleep 16
 - Using the Home button 17
 - Using the front control panel 17
 - Using the remote control 19
 - Using touch 22
 - Writing, drawing, and erasing 23
 - Adjusting the volume 24
 - Freezing or hiding the screen 25
 - Using the SMART ID card with the display 26
 - Using the microphone array 30
- Chapter 3 Using the iQ apps 32**
 - Using the Home screen 32
 - Using the Apps Library 32
 - Using the Files Library 33
 - Using SMART Whiteboard 33
 - Using Browser 33
 - Using screen share 33
 - Using screen captures 34
 - Installing third-party apps 34
 - Cleaning up the display 34
- Chapter 4 Connecting computers and other devices 35**
 - Installing and using SMART software 35
 - Connecting room computers and guest laptops 38
 - Connecting a SMART OPS PC module 46
 - Connecting USB drives, peripherals, and other devices 47

Contents

- Chapter 5 Troubleshooting 50**
 - The display isn't turning on 50
 - The screen is blank or there's a problem with the image on the screen 51
 - There's no sound or there's a problem with the sound 54
 - Touch isn't working as expected 55
 - The pens and erasers aren't working as expected 55
 - NFC sign in isn't working as expected 56
 - iQ apps aren't working as expected 57
 - SMART software on connected computers isn't working as expected 57
 - The SMART OPS PC module isn't working as expected 57
 - The Intel Compute Card isn't working as expected 57
 - Minimum required SMART Product Drivers versions 58
 - Contacting your reseller for additional support 58
- Certification and compliance 60**

Chapter 1 **Welcome**

- About this guide 6
- About the display's features and components 7
 - Touch 8
 - Writing, drawing, and erasing 8
 - iQ 8
 - Display 9
 - Audio 9
 - NFC sign in 9
 - Microphone array10
 - Network connectivity 10
 - Room computers and guest laptops 10
 - Accessory slot 11
 - Front control panel 12
 - Front connector panel 12
 - Ambient light sensor 12
 - Power status light 12
 - Remote control and IR sensor 12
- Identifying your specific model 13
- Accessories 14
 - SMART OPS PC module 14
 - Stands 14
 - USB extenders 15
- More information 15

The SMART Board® MX or MX Pro series interactive display is the hub of your classroom or meeting room.









About this guide

This guide explains how to use a SMART Board MX or MX Pro series interactive display.

This guide is intended for individuals who use displays in their organizations. Other documentation and resources are available for those who install and maintain displays (see *More information* on page 15).

Note

This guide covers the following series:

- | | |
|--|--|
|  SMART Board MX (V4) series |  SMART Board MX Pro (V4) series |
|  SMART Board MX (V3) series |  SMART Board MX Pro (V3) series |
|  SMART Board MX (V2-C) series |  SMART Board MX Pro (V2-C) series |
|  SMART Board MX (V2) series |  SMART Board MX Pro (V2) series |
|  SMART Board MX series | |

Information that applies to specific series is marked with the symbols above.

About the display's features and components

The display includes an extensive set of features and components:



Touch

You can do everything on the display that you can do at your computer—open and close applications, meet with others, create new documents or edit existing ones, visit websites, play and manipulate videos, and so on—by touching the display’s surface.

You can use an array of gestures within applications, including panning, scaling, rotating, and zooming in and out.

For more information, see *Using touch* on page 22.

Writing, drawing, and erasing

The display comes with two pens, which you can use to write or draw on the screen.

Use your fist or palm to erase digital ink on the screen.

With Object Awareness™, the display responds automatically to the tool or object you’re using, whether it’s a pen, finger, or palm. The display’s Simultaneous Tool Differentiation technologies allow two people to write independently and simultaneously.

For more information, see *Writing, drawing, and erasing* on page 23.

iQ

The display’s iQ software provides one-touch access to collaborative tools, including a whiteboard, wireless screen sharing, and a web browser. With minimal network integration, there’s no need for wires, cables, or manual software and firmware updates.

From the iQ Home screen, you can open the iQ apps, switch inputs, and adjust settings.

For more information about the Home screen, see *Using the Home button* on page 17.

For more information about the iQ apps, see *Chapter 3 Using the iQ apps* on page 32.

Display

The 4K ultra-high-definition LCD display provides optimal image clarity and wide viewing angles.

The size of the display varies by model:

Models	Size (diagonal)
SBID-MX255-V4, SBID-MX255-V4-PW, SBID-MX055-V4, SBID-MX055-V4-PW, SBID-MX255-V3N, SBID-MX255-V3, SBID-MX255-V3N-PW, SBID-MX255-V3-PW, SBID-MX055-V3N, SBID-MX055-V3, SBID-MX055-V3N-PW, SBID-MX055-V3-PW, SBID-MX255-V2-C, SBID-MX255-V2-CPW, SBID-MX255-V2, SBID-MX255-V2-PW, SBID-MX055-V2, SBID-MX055-V2-PW	55"
SBID-MX265-V4, SBID-MX265-V4-PW, SBID-MX065-V4, SBID-MX065-V4-PW, SBID-MX265-V3N, SBID-MX265-V3, SBID-MX265-V3N-PW, SBID-MX265-V3-PW, SBID-MX065-V3N, SBID-MX065-V3, SBID-MX065-V3N-PW, SBID-MX065-V3-PW, SBID-MX265-V2-C, SBID-MX265-V2-CPW, SBID-MX265-V2, SBID-MX265-V2-PW, SBID-MX065-V2, SBID-MX065-V2-PW, SBID-MX365, SBID-MX265	65"
SBID-MX275-V4, SBID-MX275-V4-PW, SBID-MX075-V4, SBID-MX075-V4-PW, SBID-MX275-V3N, SBID-MX275-V3, SBID-MX275-V3N-PW, SBID-MX275-V3-PW, SBID-MX075-V3N, SBID-MX075-V3, SBID-MX075-V3N-PW, SBID-MX075-V3-PW, SBID-MX275-V2-C, SBID-MX275-V2-CPW, SBID-MX275-V2, SBID-MX275-V2-PW, SBID-MX075-V2, SBID-MX075-V2-PW, SBID-MX375, SBID-MX275	75"
SBID-MX286-V4, SBID-MX286-V4-PW, SBID-MX086-V4, SBID-MX086-V4-PW, SBID-MX286-V3N, SBID-MX286-V3, SBID-MX286-V3N-PW, SBID-MX286-V3-PW, SBID-MX086-V3N, SBID-MX086-V3, SBID-MX086-V3N-PW, SBID-MX086-V3-PW, SBID-MX286-V2-C, SBID-MX286-V2-CPW, SBID-MX286-V2, SBID-MX286-V2-PW, SBID-MX086-V2, SBID-MX086-V2-PW, SBID-MX386, SBID-MX286	86"

Audio

The display includes two integrated speakers, designed to provide sound at the front of a room.

NFC sign in



SMART Board MX (V4) and MX Pro (V4) series models allow you to sign in to your SMART Account using near field communication (NFC): just hold your SMART ID card to the card reader area on the display's frame and enter a PIN. This feature helps you save time signing in to your account without typing your username and password.

For more information, see *Using the SMART ID card with the display* on page 26.

Microphone array



You can use SMART Board MX (V4) and MX Pro (V4) models' built-in microphone array with a conferencing app. The microphone array provides improved sound detection. You can also use the display's built-in microphone array in place of a connected computer's microphone.

For more information, see *Using the microphone array* on page 30.

Network connectivity

The display requires a network connection for downloading software and firmware updates, and a number of the iQ apps require a network connection as well.

You can connect to a network using Wi-Fi or the RJ45 LAN jack on the display:

- Wi-Fi supports both 2.4 and 5 GHz bands.
- The two RJ45 jacks allow you to connect the display and an external device, such as a computer, to an Ethernet network.

Room computers and guest laptops

You can connect room computers and guest laptops and use the display to view and interact with them.

The display comes with SMART software that you can install on connected computers to take full advantage of the display's features while using the connected computers.

For more information, see *Chapter 4 Connecting computers and other devices* on page 35.

Accessory slot



The iQ appliance is inserted in the accessory slot on the back of the following models:

- SBID-MX365
- SBID-MX375
- SBID-MX386
- SBID-MX265
- SBID-MX275
- SBID-MX286

Note

With the SBID-MX365, SBID-MX375, and SBID-MX386 models, you can insert an Intel® Compute Card in the appliance to provide a complete Windows® 10 installation at your fingertips, without the need for an external PC or cables.



For other models, you can install an OPS-compatible device, such as a SMART OPS PC module, in the accessory slot. SMART OPS PC modules provide a complete Windows Pro installation.

For more information about SMART OPS PC modules, see *SMART OPS PC module* on page 14.

⚠ Caution

The accessory slot's maximum available power depends on the display model:

Models	Maximum available power
	100 W
	60 W

The slot is not a limited power source. To reduce the risk of fire, make sure that accessories connecting to the slot satisfy the fire enclosure requirements of IEC 62368-1.

Front control panel

The front control panel contains buttons for turning the display on and off, controlling the volume, freezing and unfreezing the screen, and showing and hiding a screen shade.

For more information about the front control panel, see *Using the front control panel* on page 17.

Front connector panel

The front connector panel includes connectors for USB peripherals and a computer or other input.

For more information about the front connector panel, see *Connecting room computers and guest laptops* on page 38.

Ambient light sensor

The ambient light sensor is located in the bottom-right corner of the display's frame.

The ambient light sensor detects the brightness of the room and adjusts the screen's brightness accordingly.

Power status light

The power status light is located in the bottom-right corner of the display's frame.

The power status light indicates the display's status.

Power status light	Display status
Red	Standby mode
Green	Normal operating mode

Remote control and IR sensor





You can use the remote control to turn the display on and off, adjust display settings, and so on.

The IR sensor for the remote control is located in the bottom-right corner of the display's frame.

For more information about the remote control, see *Using the remote control* on page 19.

Identifying your specific model

There are several models of SMART Board MX and MX Pro series interactive displays:

				
SBID-MX255-V4	SBID-MX255-V3N	SBID-MX255-V2-C	SBID-MX255-V2	SBID-MX365
SBID-MX265-V4	SBID-MX255-V3	SBID-MX265-V2-C	SBID-MX265-V2	SBID-MX375
SBID-MX275-V4	SBID-MX265-V3N	SBID-MX275-V2-C	SBID-MX275-V2	SBID-MX386
SBID-MX286-V4	SBID-MX265-V3	SBID-MX286-V2-C	SBID-MX286-V2	SBID-MX265
SBID-MX255-V4-PW	SBID-MX275-V3N	SBID-MX255-V2-CPW	SBID-MX255-V2-PW	SBID-MX275
SBID-MX265-V4-PW	SBID-MX275-V3	SBID-MX265-V2-CPW	SBID-MX265-V2-PW	SBID-MX286
SBID-MX275-V4-PW	SBID-MX286-V3N	SBID-MX275-V2-CPW	SBID-MX275-V2-PW	
SBID-MX286-V4-PW	SBID-MX286-V3	SBID-MX286-V2-CPW	SBID-MX286-V2-PW	
SBID-MX055-V4	SBID-MX255-V3N-PW		SBID-MX055-V2	
SBID-MX065-V4	SBID-MX255-V3-PW		SBID-MX065-V2	
SBID-MX075-V4	SBID-MX265-V3N-PW		SBID-MX075-V2	
SBID-MX086-V4	SBID-MX265-V3-PW		SBID-MX086-V2	
SBID-MX055-V4-PW	SBID-MX275-V3N-PW		SBID-MX055-V2-PW	
SBID-MX065-V4-PW	SBID-MX275-V3-PW		SBID-MX065-V2-PW	
SBID-MX075-V4-PW	SBID-MX286-V3N-PW		SBID-MX075-V2-PW	
SBID-MX086-V4-PW	SBID-MX286-V3-PW		SBID-MX086-V2-PW	
	SBID-MX055-V3N			
	SBID-MX055-V3			
	SBID-MX065-V3N			
	SBID-MX065-V3			
	SBID-MX075-V3N			
	SBID-MX075-V3			
	SBID-MX086-V3N			
	SBID-MX086-V3			
	SBID-MX055-V3N-PW			
	SBID-MX055-V3-PW			
	SBID-MX065-V3N-PW			
	SBID-MX065-V3-PW			
	SBID-MX075-V3N-PW			
	SBID-MX075-V3-PW			
	SBID-MX086-V3N-PW			
	SBID-MX086-V3-PW			

Tip

For SMART Board MX (V2), MX Pro (V2), or later series models, you can use the label on the display's left side to identify its series. For more information, see *Contacting your reseller for additional support* on page 58.

Accessories

Accessories for the display include:

- SMART OPS PC module
- Stands
- USB extenders

Note

For more information about these and other accessories, see smarttech.com/accessories.

SMART OPS PC module

SMART Open Pluggable Specification (OPS) PC modules provide a hassle-free Windows Pro installation based on Intel Core™ processors and are designed specifically to work with a SMART Board interactive display. All OPS PC modules are fully licensed with Windows Pro. Install the OPS PC module in a display's accessory slot to provide a complete 4K UHD Windows installation at your fingertips, without the need for an external PC or additional cables.

Install familiar Windows applications, such as SMART Notebook®, SMART TeamWorks™, and SMART Meeting Pro® software, and access the internet directly through your display's network connection. Upgrades and service for the OPS PC module are easy to perform without removing the display from its mounting.

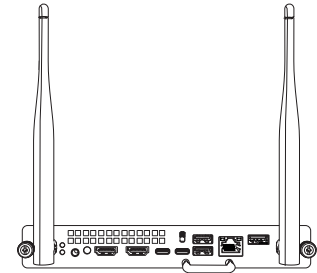

Stands

If you want to move the display from place to place, you can install it on a SMART mobile stand. If you are installing the display on a wall that cannot support the display's full weight, you can install the display on a SMART floor stand.

USB extenders

As noted in the display's specifications, there is a maximum length for USB cable connections between the display and computer.

Use the USB-XT extender if you need a longer USB connection. See the *USB-XT extender specifications* (smarttech.com/kb/119318).

Note

For more information about extending USB connections, see [USB cable extenders](#).

More information

In addition to this guide, SMART provides other documents for the display in the Support section of the SMART website (smarttech.com/support). Scan the QR code on page 2 to view links to SMART Board MX and MX Pro series interactive display documents and other support resources.

Chapter 2 Using basic features

Waking up the display and putting it back to sleep	16
Using the Home button	17
Using the front control panel	17
Using the remote control	19
Using touch	22
Writing, drawing, and erasing	23
Writing and drawing in digital ink	23
Using the SMART Ink dynamic (floating) toolbar	24
Changing a pen's default color, thickness, and other properties	24
Erasing digital ink	24
Adjusting the volume	24
Freezing or hiding the screen	25
Freezing the screen	25
Showing and hiding the screen shade	25
Using the SMART ID card with the display	26
Setting up a SMART ID card	27
Signing in to your SMART Account using your SMART ID card	28
Locking and unlocking your display using your SMART ID card	28
Managing your SMART ID card	29
Using the microphone array	30

This chapter explains how to wake the display when it's asleep, how to view connected computers' input, and how to interact with the display.

Waking up the display and putting it back to sleep

To wake the display, press the **Power** button  on the front control panel or remote control.

To return the display to a partial sleeping state, press the **Power** button  on the front control panel or remote control.

Note

Touch is not available immediately after waking or turning on the display. Wait a few seconds, and then the display will respond to touch.

For information about turning the display off, see *SMART Board MX and MX Pro series interactive displays installation and maintenance guide* (smarttech.com/kb/171555).

Using the Home button

You can use the Home screen to open and use iQ apps, view the input of connected computers, and more. You can also change the background and personalize other features of the Home screen. To learn more about the Home screen, see [Understanding the Home screen](#).

The Input screen shows thumbnails of connected computers and allows you to switch among inputs.

You can return to the Home screen or the Input screen at any time by following the instructions below.

To show the Home screen or the Input screen



Press the **Home** button  below the screen.

OR

Press the **Home** button  on the remote control.



Press the **Home** button  on the front control panel or remote control.





Tap  at the bottom of the screen.

Using the front control panel

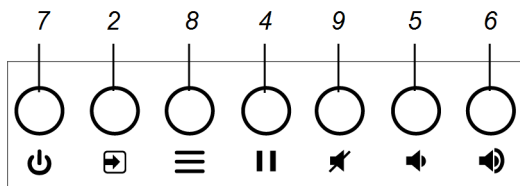
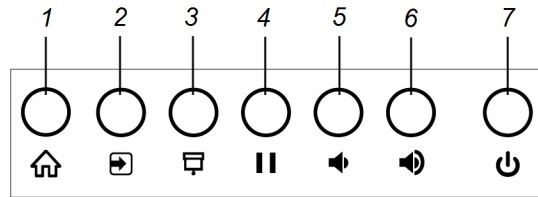
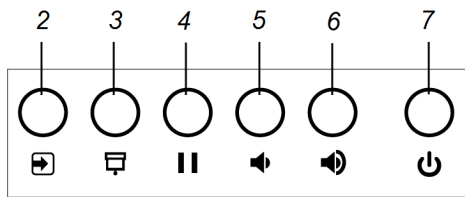
Depending on the model, the front control panel contains buttons for returning to the iQ Home screen, switching inputs, showing and hiding a screen shade, controlling the volume, freezing and unfreezing the screen, and turning the display on and off.



No.	Name	Procedure
1	Home	<p>Press to return to the iQ Home screen (see <i>Using the Home button</i> on the previous page).</p> <p>Note</p> <ul style="list-style-type: none"> For SMART Board MX (V4) and MX Pro (V4) series models, the Home button  is below the screen. For SMART Board MX series models, the Home button  is on the bottom of the screen.
2	Input select	Press to switch inputs (see <i>Viewing a connected computer's input</i> on page 44).
3	Screen shade	Press to hide screen contents behind a screen shade (see <i>Freezing or hiding the screen</i> on page 25).
4	Freeze	Press to freeze and unfreeze the screen (see <i>Freezing the screen</i> on page 25).
5	Volume decrease	Press to turn down the volume (see <i>Adjusting the volume</i> on page 24).
6	Volume increase	Press to turn up the volume (see <i>Adjusting the volume</i> on page 24).
7	Power	Press to wake the display and press again to enter Sleep mode (see <i>Waking up the display and putting it back to sleep</i> on page 16).
8	Menu	Press to open the display's settings.
9	Mute	Press to mute or unmute the volume.

Using the remote control

The display comes with an infrared remote control.

Use the infrared remote control to turn the display on or off, switch inputs, control the volume, access the display's iQ apps, and more. You can also use the remote control to open the on-screen menus and change the display's settings.

! Important

- Do not subject the remote control to strong shock.
- Keep the remote control away from liquids. If it gets wet, wipe it dry immediately.
- Do not expose the remote control to heat or steam.
- Do not open any part of the remote control other than the battery compartment.



The image and table below list the remote control's functions.

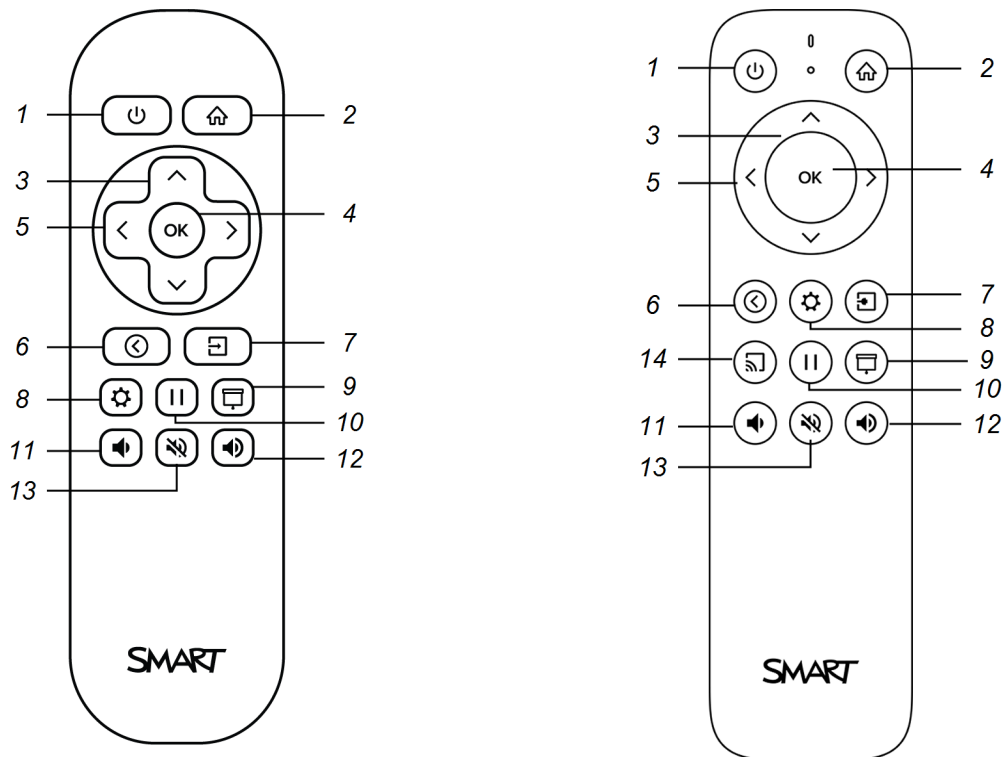

No.	Name	Procedure
1	Power	<ul style="list-style-type: none"> Press to enter or exit Standby mode (see <i>Waking up the display and putting it back to sleep</i> on page 16). <p>Note</p> <p>Touch is not available immediately after waking or turning on the display. Wait a few seconds, and then the display will respond to touch.</p> <ul style="list-style-type: none"> Press and hold for four seconds to turn off the display.
2	Home	Open the iQ Home screen (see <i>Using the Home button</i> on page 17).
3	Up and down buttons	Select a menu option in the settings.
4	OK	Select menu option in the settings.
5	Left and right buttons	Change the value of the selected setting.
6	Back	Go one step back in the navigation history.
7	Input	Switch inputs (see <i>Viewing a connected computer's input</i> on page 44).
8	Settings	Open display settings.
9	Screen shade	Hide screen contents behind a screen shade (see <i>Showing and hiding the screen shade</i> on page 25).
10	Freeze frame	Freeze and unfreeze the screen (see page 25).
11	Volume increase	Increase the volume (see <i>Adjusting the volume</i> on page 24).
12	Volume decrease	Decrease the volume (see <i>Adjusting the volume</i> on page 24).
13	Volume mute	Mute the volume (see <i>Adjusting the volume</i> on page 24).
14	Share screen	<p>Open the Screen Share app (see <u>Sharing your device's screen to the display</u>).</p> <p>Note</p> <p>This button is not available on all remote control models.</p>



The image and table below list the remote control's functions.

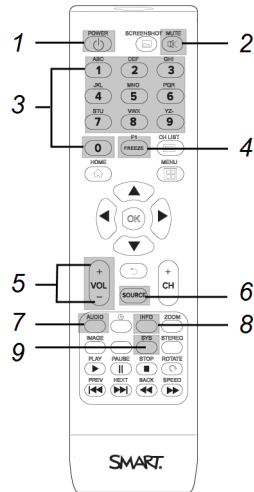

No.	Name	Procedure
1	Power	Press to enter or exit Standby mode (see <i>Waking up the display and putting it back to sleep</i> on page 16).
2	Mute	Mute or unmute the volume (see <i>Adjusting the volume</i> on page 24).
3	[Number buttons]	Press buttons on the number pad to customize settings.
4	Freeze frame	Freeze and unfreeze the screen (see page 25).
5	Volume increase/decrease	Increase or decrease the volume (see <i>Adjusting the volume</i> on page 24).
6	Source	Switch inputs (see <i>Viewing a connected computer's input</i> on page 44).
7	Audio	Change the display's audio mode.
8	Info	Show the display's detected resolution and refresh rate for the current input.
9	Settings	Open display settings.

Note

The buttons listed in this table and highlighted in gray in the image above are the only ones that have an effect on the display. Pressing the other buttons will make the remote control sensor flash, but they have no effect.

Using touch

You can do everything on the SMART product that you can do at your computer—open and close applications, meet with others, create or edit documents, visit websites, play and manipulate videos, and so on—by touching the SMART product’s surface.

You can use a variety of gestures within applications, including panning, scaling, rotating, and zooming in and out.

The display’s support for up to 20 simultaneous interaction points enables you and other users to interact with objects on the screen at the same time.

Note

Not all gestures work in all applications. Refer to an application’s documentation to learn which gestures it supports.

Pan (one finger)

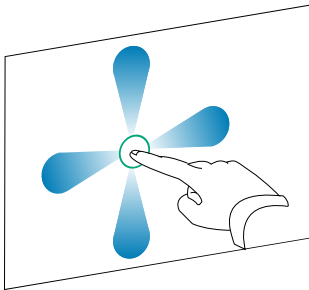

Pan (two fingers) / scroll

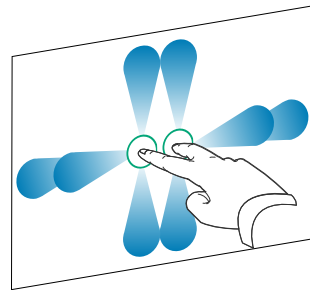

Pinch to zoom in / scale (enlarge)

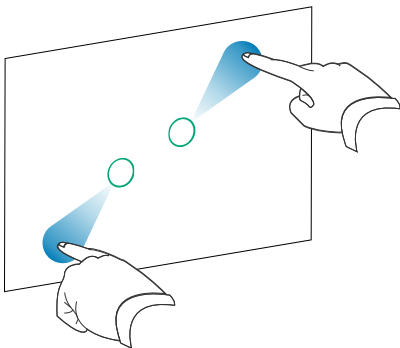

Pinch to zoom out / scale (reduce)

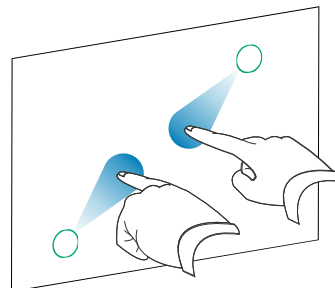

Rotate

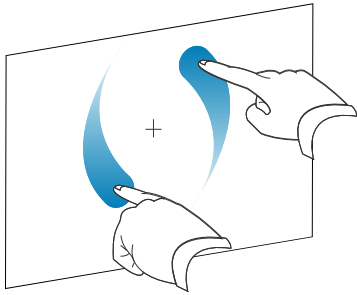

Flick

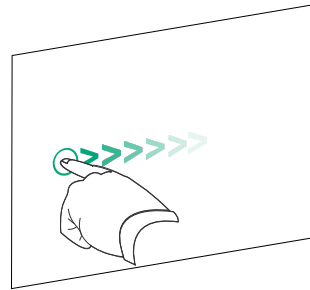

Erase with palm

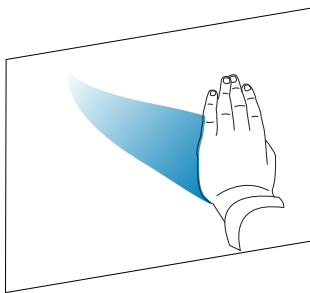

Erase with fist

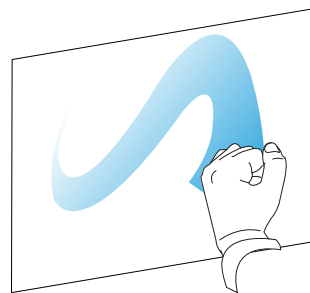

Writing, drawing, and erasing

The display includes two pens, which you can use to write or draw in digital ink. You can erase digital ink using gestures or the eraser tool in the apps.

Writing and drawing in digital ink

1. Pick up one of the display's pens.
2. Use the pen to write or draw in digital ink.

Using the SMART Ink® dynamic (floating) toolbar

When you start drawing on the screen while viewing a connected computer's input, the SMART Ink dynamic (floating) toolbar for SMART Ink appears on the screen. You can use this toolbar to temporarily change the pen's color, thickness, or other properties. You can also access SMART Ink's other tools, such as screen capture, spotlight, screen shade, and so on.



To learn more about SMART Ink and its toolbar, visit the [SMART Product Drivers and Ink support page](#). Here are a few quick links to get you started:

- [Turning SMART Ink on or off](#)
- [Opening the dynamic \(floating\) toolbar](#)
- [Closing \(hiding\) the toolbar](#)
- [Using presentation tools](#)

Changing a pen's default color, thickness, and other properties

You can change a pen's color, thickness, and other properties temporarily using the SMART Ink dynamic (floating) toolbar when you're viewing a connected computer's input.

To change the pen's default color, thickness, and other properties, see [Changing pen, eraser, and button settings](#).

Erasing digital ink

You can erase digital ink from the screen using your palm or fist.

To erase digital ink

Move your fist or palm over the digital ink you want to erase.





Adjusting the volume

Use the buttons on the front control panel or the remote control to increase, decrease, or mute the display's volume.



Note

See *There's no sound or there's a problem with the sound* on page 54 if you encounter issues with the display's sound.

To turn the volume up or down

Press the **Volume Up** button  or **Volume Down** button  on the front control panel or the remote control.

Notes

- Press and hold the **Volume Down** button  to rapidly decrease the volume.
- When you press the **Volume Up** button  or **Volume Down** button  on the front control panel or the remote control, you can use the on-screen slider to adjust the volume.

To mute the volume

Press the remote control's **Mute** button .

Freezing or hiding the screen

You can temporarily freeze or hide the screen contents using the display's freeze and screen shade features.

Freezing the screen

You can temporarily freeze the screen by pressing the **Freeze** button  on the front control panel or remote control. This is particularly useful when you want to pause a video, an animation, or other moving images.

Note

Freezing the screen does not pause applications that are running on the connected computer or audio. It simply freezes the display of those applications.

Tip

You can write or draw over the screen while it is frozen (see *Writing, drawing, and erasing* on page 23). If iQ is enabled, you can then save the screenshot of your writing or drawing to the Files Library (see [Opening and managing files](#)).

To unfreeze the screen, press the **Freeze** button  again.

Showing and hiding the screen shade



You can temporarily hide the contents of the screen behind a virtual screen shade by pressing the **Screen Shade** button  on the front control panel or remote control.

To remove the screen shade and reveal the screen contents, press the **Screen Shade** button  again.

Using the SMART ID card with the display



The SMART Board MX (V4) and MX Pro (V4) series models' integrated RFID NFC reader/writer technology enables you to sign in to your SMART Account by holding a SMART ID card to the card reader area on the display's frame (pictured below) and then typing your PIN.

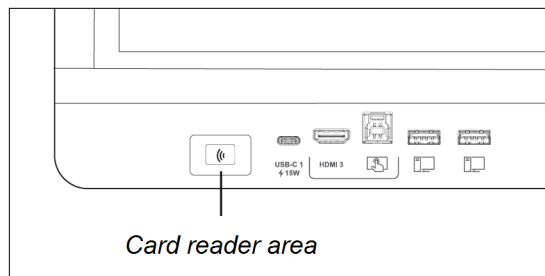

After you set up your SMART ID card, you can use it to sign in to any NFC-enabled SMART Board interactive display with iQ.

Signing in with your SMART ID card gives you access to the usual features of your SMART Account. You can personalize the display's settings (such as the display's wallpaper) and download files from Google Drive™ or OneDrive™. If your SMART Account is connected to an active SMART Learning Suite subscription, you can also sync all your lesson files from SMART Notebook software and Lumio™ by SMART to the display.

NFC sign in requires:

- iQ system version 3.12 SP2 or later.
- the display to be connected to a network.

Important

Only SMART ID cards are supported.

Notes

- When you hold your SMART ID card to the card reader area on the frame, keep the card as flat as possible.
- If you select a different service region, you'll need to set up your SMART ID card again by removing the card and setting it up again.

- If you're signed in to your SMART Account on one display but then sign in on a second display, you'll be signed into your SMART Account on both displays.

Tip

After signing into your SMART Account, be sure to sign out at the end of the session to keep your account secure. For extra security, IT administrators can enable the *Automatic inactivity log out* setting within **Settings > Security** to make the display sign out of a user's SMART Account automatically after a period of inactivity.

Setting up a SMART ID card

1. Tap your profile avatar to open the *Notification Center*.



2. At the bottom of the Notification Center, tap **Sign In** and choose an option for signing in to your SMART Account. Enter your user name password when prompted.
3. Open the Notification Center again and tap **Edit account > Set up ID card > Add ID card**.
4. Type a PIN (which can also include symbols for added security), and tap **Next**.

You use this PIN when you use your SMART ID card to sign in to your SMART Account. This is designed to prevent your SMART ID card being used by an unauthorized user.

5. Re-type the PIN and tap **Next**.
6. Hold your SMART ID card to the card reader area on the frame for 1 or 2 seconds.
7. When prompted, hold your SMART ID card to the card reader area on the frame again for 1–6 seconds.

Your SMART ID card is now set up and you can use it to sign in to your SMART Account on any NFC-enabled SMART Board interactive display that's connected to a network.

Signing in to your SMART Account using your SMART ID card

To use your SMART ID card to sign in to your SMART Account

1. Hold your SMART ID card to the card reader area on the frame for 1 or 2 seconds.
2. Enter your PIN and tap **Next**.
3. Hold your SMART ID card to the card reader area on the frame for 1 or 2 seconds.

You are signed in to your SMART Account on the display.

To sign out of your SMART Account

1. Tap your profile avatar to open the Notification Center.



2. At the bottom of the Notification Center, tap **Sign out**.

Locking and unlocking your display using your SMART ID card

Notes

- Locking and unlocking your display using your SMART ID card is supported in iQ system version 3.11 or later.
- You must set up your SMART ID card before using it to lock and unlock the display (see *Setting up a SMART ID card* on the previous page).
- You must be signed in to your SMART Account to use your SMART ID card to lock and unlock the display (see *Signing in to your SMART Account using your SMART ID card* above).
- You can also temporarily lock your display with a PIN to prevent unauthorized access. See [Setting up a lock screen PIN](#). If you attempt to use a SMART ID card other than the one used to lock the screen, you'll need to enter a Lock Screen PIN to unlock the screen.

To lock your display using your SMART ID card

Hold your SMART ID card to the card reader area on the frame for 1 to 2 seconds.

To unlock your display using your SMART ID card

Hold your SMART ID card to the card reader area on the frame for 1 to 2 seconds.

Note

If you attempt to unlock the screen using a SMART ID card that is different to the one used to lock the screen, you'll be prompted to enter the lock screen PIN. For information about using the lock screen PIN, see [Setting up a Lock Screen PIN](#).

Managing your SMART ID card

To change the PIN associated with your SMART ID

Note

If you choose a new PIN, you won't be able to unlock your screen using your old PIN.

1. Sign in to your SMART Account on your display (see *Signing in to your SMART Account using your SMART ID card* on the previous page).
2. Tap your profile avatar to open the Notification Center.



3. At the bottom of the Notification Center, tap **Edit account > Reset ID card PIN**.
4. Type a new PIN (which can also include symbols for added security), and tap **Next**.
5. Hold your SMART ID card to the card reader area on the frame for 1 or 2 seconds.
6. When prompted, hold your SMART ID card to the card reader area on the frame again for 1–6 seconds.

The PIN associated with your SMART ID card has now been changed.

To remove a SMART ID card from your SMART Account

Note

If you remove a SMART ID card from your SMART Account, you'll no longer be able to use that card to sign in to your account.

1. Sign in to your SMART Account on your display (see *Signing in to your SMART Account using your SMART ID card* on page 28).
2. Open the Notification Center and tap **Edit account > Remove ID card**.
3. Tap **Remove**.

The SMART ID card has now been removed from your Account.

Using the microphone array



You can use the microphone array to capture audio while using a conferencing app on your display. You can also connect a room computer or guest laptop to the display and use the display's built-in microphone array in place of the connected computer's. The microphone array provides improved sound selection and noise cancellation.

Note

To learn more about installing third-party apps, see [Adding and managing apps in the iQ experience](#).

To use the microphone array with the display's conferencing apps

Start the conferencing app on the display.

If the display's microphone array is not automatically selected, open the sound controls in the conferencing app and select **SMART IFP Mic** from the list of sound input devices.

Tip

Use the sound controls in your display's conferencing app to adjust settings such as background noise reduction and microphone sensitivity.

To use the microphone array with a connected computer

1. Connect the computer to the display and select it as the display's input. (see *Viewing a connected computer's input* on page 44).

2. Open the sound controls on the connected computer.

Windows computer

Select **Start > Settings > System > Sound > Input > Choose your input device**.

Mac computer

Select **Apple menu > System Preferences**, click **Sound**, then click **Input**.

3. Select **SMART IFP Mic** from the list of sound input devices.

Tip

Use the connected computer's sound controls to adjust settings such as input volume and background noise reduction.

To set the microphone array as the default microphone when using a conferencing app on a connected computer

1. Connect the computer to the display and select it as the display's input (see *Viewing a connected computer's input* on page 44).
2. Start the conferencing app on the computer.
3. Open the conferencing app's sound controls and select **SMART IFP Mic** from the list of sound input devices.

Tip

Use the conferencing app's sound controls to adjust settings such as input volume and background noise reduction.

Chapter 3 Using the iQ apps

Using the Home screen	32
Using the Apps Library	32
Using the Files Library	33
Using SMART Whiteboard	33
Using Browser	33
Using screen share	33
Using screen captures	34
Installing third-party apps	34
Cleaning up the display	34

Using the Home screen

iQ's Home screen shows recent files and favorite apps and files.

To show the Home screen

Tap the Home button at the bottom of the screen.

To learn how to use the other features of Home screen, see [Understanding the Home Screen](#).

Using the Apps Library

The Apps Library contains the Browser and SMART Whiteboard. You can also add apps from the web and SMART's app store or install third-party apps.

To open the Apps Library

From the Home screen, tap **Apps** .

To learn how to use the other features of Apps Library, see [Understanding the Apps Library](#).

Using the Files Library

The Files Library contains SMART Notebook files, SMART Whiteboards, PDFs, and screenshots. If a USB drive is connected to the display, the files on the USB drive are also available in the Files Library. Although these files can be viewed on the display, they are not saved on the display.

To open Files Library

From the Home screen, tap **Files** .

To learn how to use the other features of Files Library, see [Understanding the Files Library](#).

Using SMART Whiteboard

Use the SMART Whiteboard in iQ to create whiteboards and open, view, and interact with SMART Notebook lesson files.

To learn more about the SMART Whiteboard, see [About the SMART Whiteboard tools](#).

Using Browser

You can use Browser to view web sites on the display.

To learn more about Browser, see [Browsing the internet on your display](#).

Using screen share

You can share the screens from computers and mobile devices on the display wirelessly using screen share.

Screen share supports the following devices:

- Chromebook™ laptops, using Google Cast™
- Windows computers, using Miracast¹ or Google Cast Chrome™ browser extension
- Mac computers and iOS devices, using AirPlay
- Android™ devices, using Cast Screen

To learn how to use the other features of Screen Share, see [Sharing your device's screen to the display](#).

¹Windows 10 operating system only

Using screen captures

When using the Browser or screen share apps, you can write or draw on an annotation layer and save a screen capture to the Files library.

To learn more about screen captures, see [Writing and drawing over apps](#).

Installing third-party apps

You can install third-party apps from the Google Play™ store using SMART Remote Management.

To learn more about installing third-party apps, see [Deploying third-party apps on your display](#).

Cleaning up the display

After you've finished using the display, open the launcher and tap **Clean Up**  to clean up the display for the next user.

To learn more, see [Preparing the display for the next user](#).

Chapter 4 Connecting computers and other devices

Installing and using SMART software	35
Downloading and installing SMART software	36
Using SMART software	37
Connecting room computers and guest laptops	38
Viewing a connected computer's input	44
Setting a connected computer's resolution and refresh rate	45
Troubleshooting connected computers	46
Connecting a SMART OPS PC module	46
Connecting USB drives, peripherals, and other devices	47

Warning

Ensure that any cables that cross the floor to the display are properly bundled and marked to avoid a trip hazard.

Installing and using SMART software

The display comes with the following software, which you can install on connected computers:

Software	Description	Notes
SMART Notebook	Free software designed for use with a SMART Board interactive display. SMART Notebook software comes with many features that you can use to create, edit, and deliver engaging lessons for your students.	See SMART Notebook .
SMART Meeting Pro	Software that enables you to capture ideas in a virtually unlimited interactive workspace.	Pro models only.
SMART Product Drivers	Software that enables the computer to detect input from the display.	Included with SMART Notebook and SMART Meeting Pro software.

Software	Description	Notes
SMART Ink	Software that enables you to write and draw in digital ink over applications, files, folders, websites, and any other open window.	Included with SMART Notebook and SMART Meeting Pro software.
SMART Remote Management	Cloud-based mobile device management software for remotely maintaining, supporting, controlling, and securing the display and your other devices.	Subscription for length of the included warranty. ¹

Tip

You can purchase additional licenses or subscriptions to SMART software to install on other computers.

The following software is also available but sold separately:

Software	Description	Notes
SMART Learning Suite	A suite of desktop and online software that combines lesson delivery, activities, assessments, and collaborative workspaces. Includes SMART Notebook Plus software and Lumio by SMART.	For more information, see SMART Learning Suite .
SMART TeamWorks Room	Software that simplifies meetings and facilitates deeper, more natural interaction with onsite and remote participants.	For more information, see SMART TeamWorks .

Contact your authorized SMART reseller (smarttech.com/where) for information about purchasing SMART software.

Downloading and installing SMART software

You can download SMART software from smarttech.com/downloads and install it following the instructions in [Installing and maintaining SMART Notebook](#), [Installing SMART TeamWorks](#), or [Installing and maintaining SMART Meeting Pro](#).

¹Subscription terms may vary in some regions.

Using SMART software

For information about using SMART software, see the following pages in the Support section of the SMART website:

- [SMART Notebook](#)
- [Lumio by SMART](#)
- [SMART Learning Suite](#)
- [SMART TeamWorks](#)
- [SMART Meeting Pro](#)
- [SMART Product Drivers and Ink](#)
- [SMART Remote Management](#)

SMART Product Drivers and Ink are installed and used on computers connected to the display to enable touch and digital ink features. This supporting software is included with SMART's software products, such as [SMART Notebook](#), [SMART Meeting Pro](#), and [SMART TeamWorks](#), and is also available for free download.

SMART Product Drivers and Ink software have a number of features you can use to customize default settings for your display and troubleshoot common issues:

- [Adjust touch, mouse, and gesture settings](#)
- [Turn SMART Ink on or off](#)
- [Use SMART Ink in Microsoft® Office products](#)

Connecting room computers and guest laptops

You can connect room computers and guest laptops to the display and view and interact with their inputs.



Side and bottom connector panels

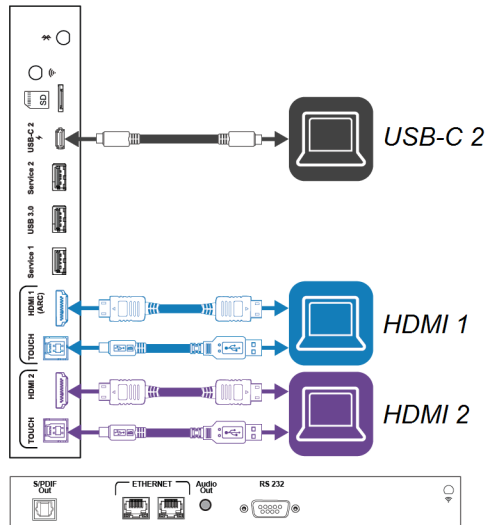

Front connector panel

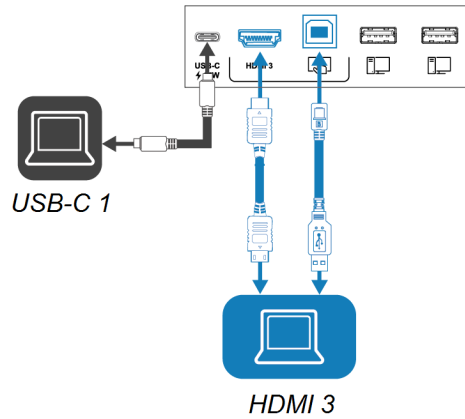



Side and bottom connector panels

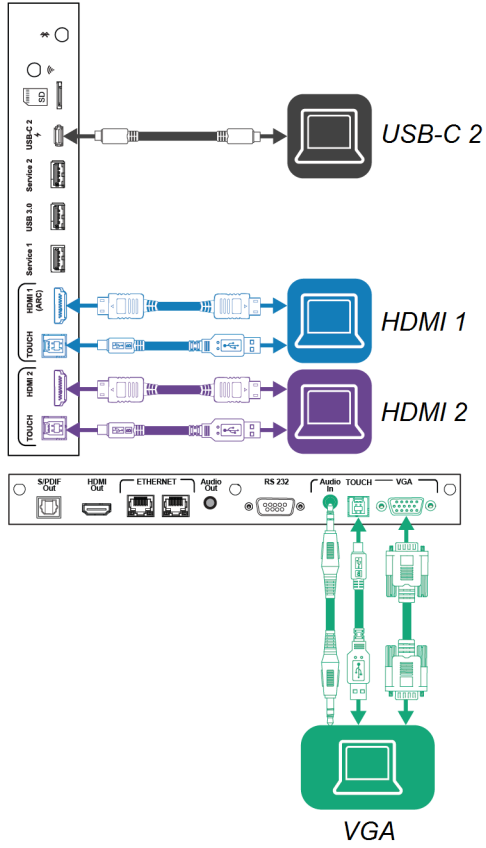

Front connector panel

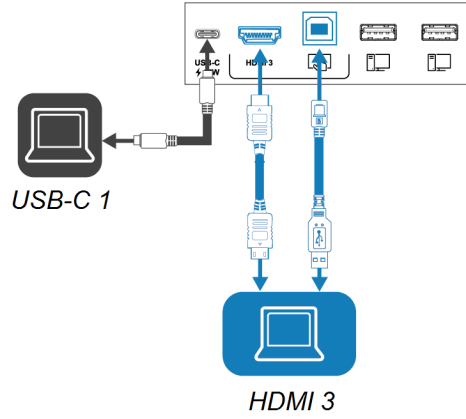



Side and bottom connector panels

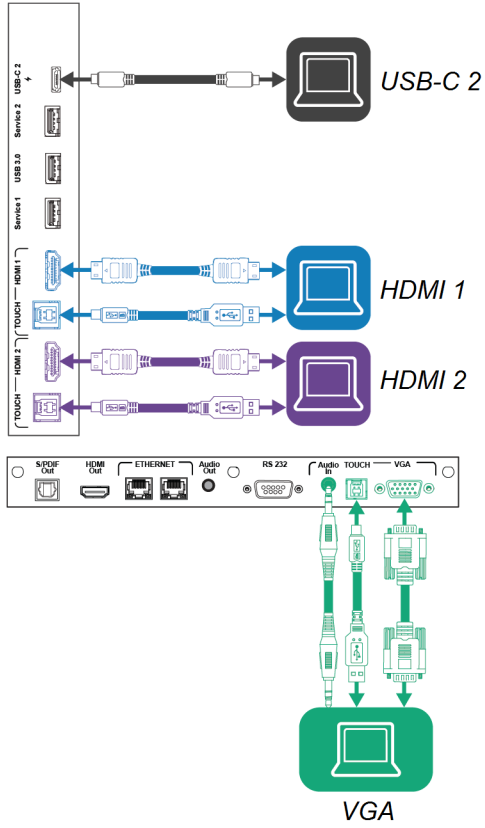

Front connector panel

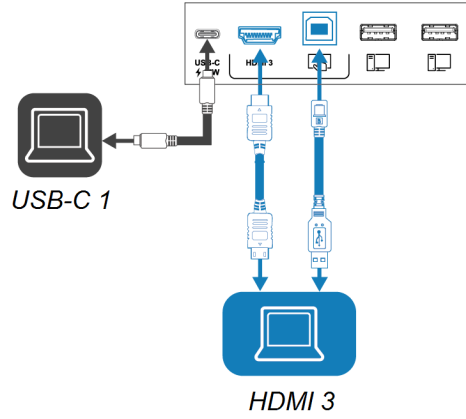



Side and bottom connector panels

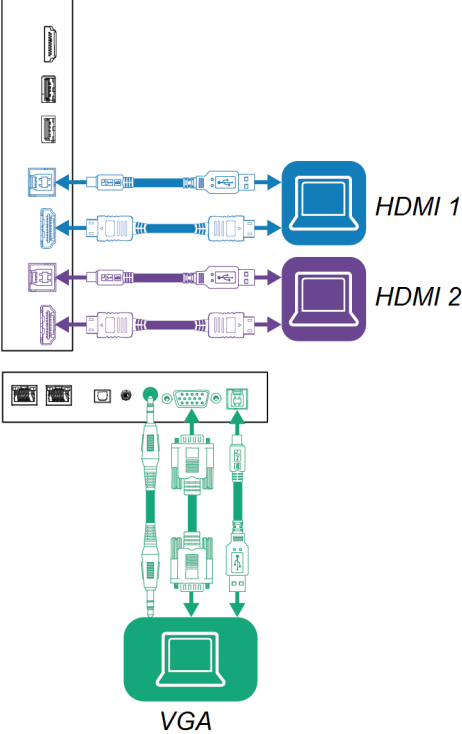

Front connector panel

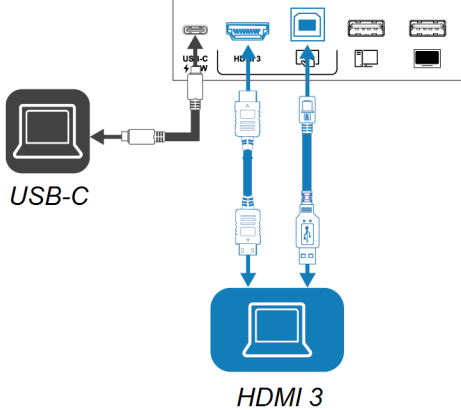



Side and bottom connector panels

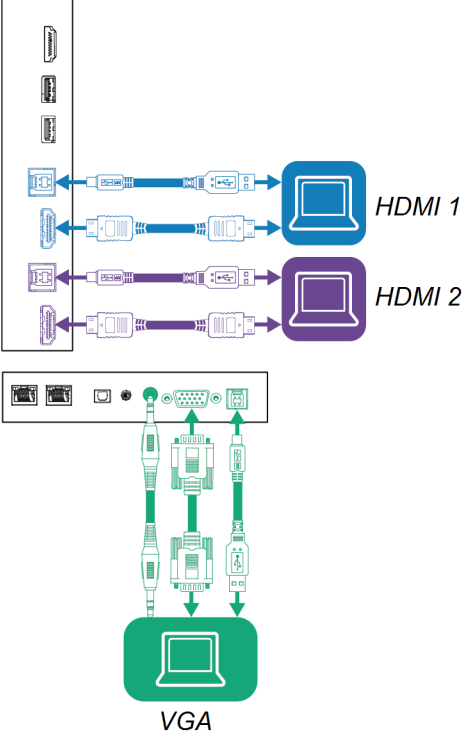

Front connector panel

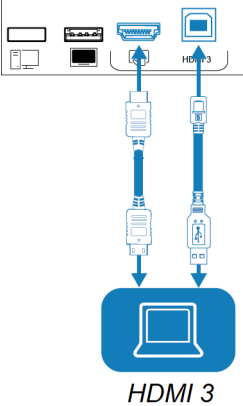



Side and bottom connector panels

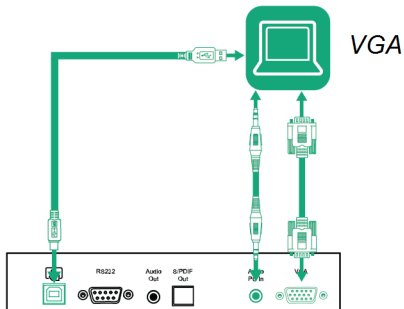
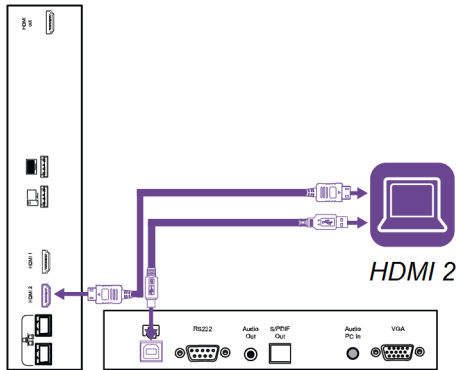
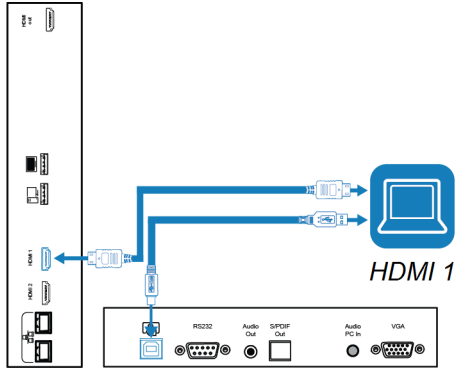

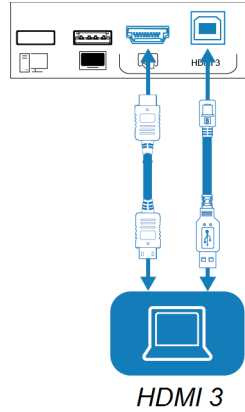

Front connector panel



Notes

- Install SMART software on any computers you connect to the display (see *Installing and using SMART software* on page 35).





- Your organization’s installers might have connected cables to the display and run the cables behind a wall or under the floor to a desk or table where you can place your computer.
- You can charge devices using the display’s USB Type-C receptacles:

Models	USB Type-C receptacle location	Maximum charging capacity
	Front connector panel	15 W
	Side connector panel (when a module is not installed in the accessory slot)	65 W
	Side connector panel (when a module is installed in the accessory slot)	30 W

- If a connected computer reports “Too many USB hubs” or “cannot start (code 10),” see the knowledge base article, [SMART Board interactive displays and USB tier structure use](#).

Viewing a connected computer’s input



1. Connect the computer to the display.
2. View the available inputs in one of the following ways:
 - If iQ is enabled, tap **Input**  on the Home screen.
 - OR
 - If iQ is disabled, press the **Home** button ( or .
 - Press **Input**  on the front control panel.
 - Press **Input**  on the remote control.

The display shows thumbnails of the devices that are connected to the display’s inputs:

- A gray thumbnail indicates no device is connected to an input.
- A black thumbnail indicates a device is connected to an input but is in Standby mode.
- A thumbnail showing a preview screen indicates an active device is connected to an input.

- A thumbnail with **Touch enabled**  indicates a USB cable is connected between the display and device and touch is available.

3. Tap the computer's thumbnail.



1. Connect the computer to the display.
2. Press the **Input**  on the front control panel.

The Input selection menu appears.

Note

Inputs with connected devices are blue, and inputs without a connection are black.

3. Tap the computer's input menu option.

Setting a connected computer's resolution and refresh rate

This table presents the recommend resolutions and refresh rates for the display's USB-C and HDMI inputs:

Resolution	Input aspect ratio	Mode	Refresh rate
3840 × 2160	16:9	UHD / 2160p	59.94 Hz / 60 Hz 50 Hz 29.97 Hz / 30 Hz 25 Hz 23.98 Hz / 24 Hz
1920 × 1080	16:9	FHD / 1080p	59.94 Hz / 60 Hz 50 Hz 29.97 Hz / 30 Hz 25 Hz 23.98 Hz / 24 Hz
1360 × 768	16:9	HD	60.015 Hz
1366 × 768	16:9	HD	60.015 Hz

Resolution	Input aspect ratio	Mode	Refresh rate
1280 × 720	16:9	HD / 720p	59.94 Hz / 60 Hz 50 Hz 29.97 Hz / 30 Hz 25 Hz 23.98 Hz / 24 Hz
720 × 480	16:9	480p (DVD Player)	60 Hz

This table presents the recommend resolutions and refresh rates for the display’s VGA input:

Resolution	Input aspect ratio	Mode	Refresh rate
1920 × 1080	16:9	[N/A]	60.000 Hz
1600 × 1200	4:3	[N/A]	60.000 Hz
1360 × 768	16:9	[N/A]	60.015 Hz
1280 × 1024	5:4	SXGA 60	60.020 Hz
1024 × 768	4:3	XGA 60 XGA 70 XGA 75	60.004 Hz 70.069 Hz 75.029 Hz
800 × 600	4:3	SVGA 60 SVGA 72 SVGA 75	60.317 Hz 72.188 Hz 75.000 Hz
640 × 480	4:3	VGA 60	59.940 Hz

If possible, set connected computers to these resolutions and refresh rates. See the connected computers’ operating system documentation for instructions.

Troubleshooting connected computers

For troubleshooting information for connected computers, see *Chapter 5 Troubleshooting* on page 50.

Connecting a SMART OPS PC module

If your organization has purchased a SMART OPS PC module, you or your organization’s installers can install the OPS PC module in the display’s accessory slot following the OPS PC module’s installation instructions (smarttech.com/kb/171775 or smarttech.com/kb/171544). You can then view the OPS PC module’s input on the display.

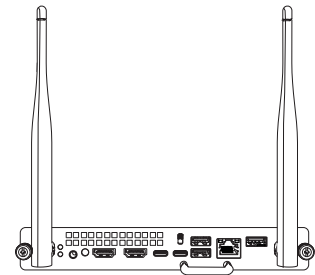

For more information about SMART OPS PC modules, see the *SMART OPS PC modules user guide* (smarttech.com/kb/171747).

Connecting USB drives, peripherals, and other devices

The display includes the following USB receptacles. You can connect USB drives, peripherals (such as keyboards), and other devices to these receptacles and use the devices with iQ, connected computers, and devices installed in the accessory slot (such as the SMART OPS PC module).

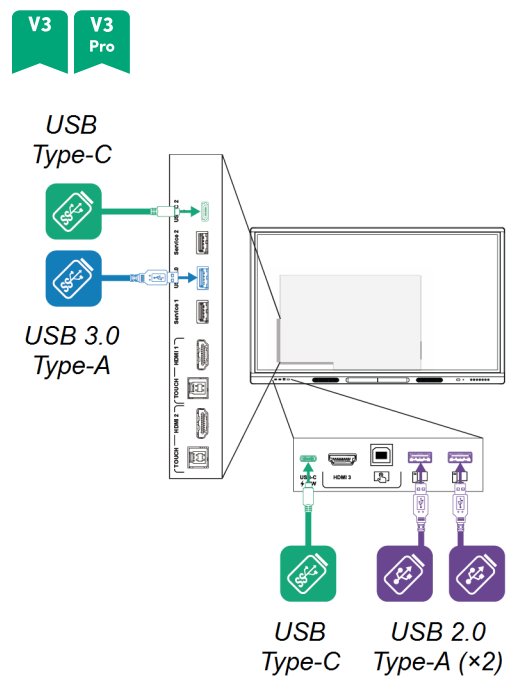
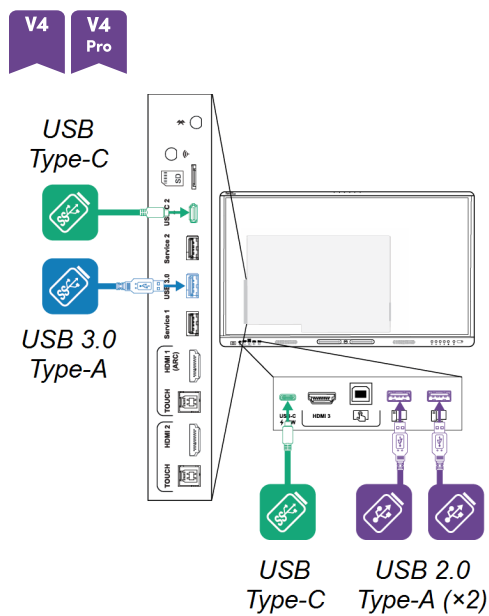

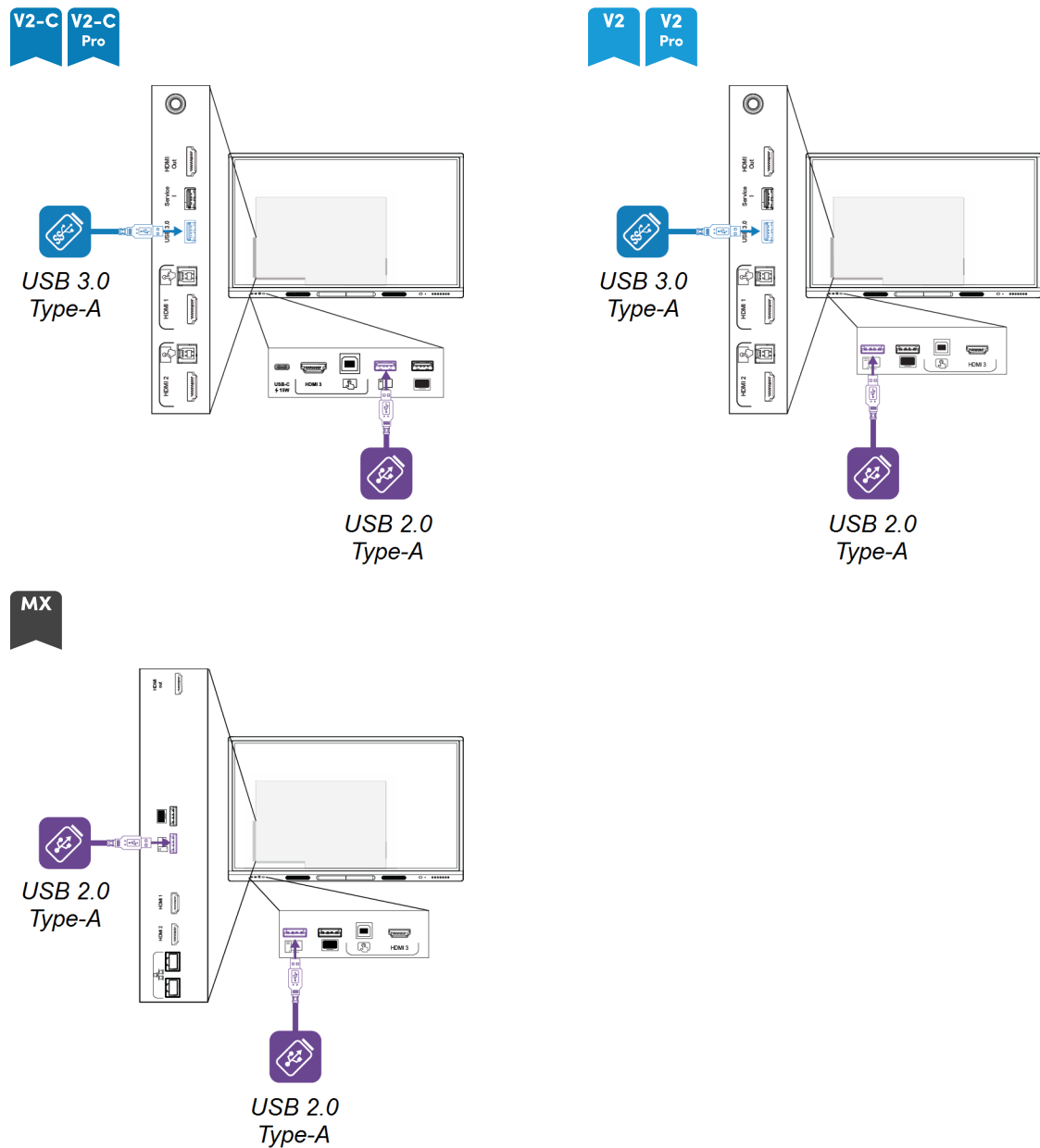

This table shows the supported USB speeds for each input:

Input	USB 2.0 Type-A	USB 3.0 Type-A	USB Type-C
iQ	Hi-Speed	SuperSpeed	SuperSpeed
USB-C 1	Hi-Speed	Hi-Speed	Hi-Speed
USB-C 2	Hi-Speed	Hi-Speed	Hi-Speed

Input	USB 2.0 Type-A	USB 3.0 Type-A	USB Type-C
HDMI 1	Hi-Speed	SuperSpeed	SuperSpeed
HDMI 2	Hi-Speed	SuperSpeed	SuperSpeed
HDMI 3	Hi-Speed	SuperSpeed	SuperSpeed
VGA	Hi-Speed	SuperSpeed	SuperSpeed
Accessory slot	Hi-Speed	SuperSpeed	SuperSpeed

Chapter 5 Troubleshooting

The display isn't turning on	50
The screen is blank or there's a problem with the image on the screen	51
There's no sound or there's a problem with the sound	54
Touch isn't working as expected	55
The pens and erasers aren't working as expected	55
NFC sign in isn't working as expected	56
iQ apps aren't working as expected	57
SMART software on connected computers isn't working as expected	57
The SMART OPS PC module isn't working as expected	57
The Intel Compute Card isn't working as expected	57
Minimum required SMART Product Drivers versions	58
Contacting your reseller for additional support	58



This chapter explains how to resolve a variety of common issues with the display. If your specific symptoms aren't covered below or the solutions to the symptoms don't work, refer to the SMART knowledge base for additional troubleshooting information:

community.smarttech.com/s/topic/0TO0P000000Xt5yWAC/mx-series











The display isn't turning on

Symptom	Troubleshooting steps
The power light isn't lit.	<ul style="list-style-type: none"> • Make sure the switch beside the AC power inlet is in the ON (I) position. • Make sure the power cable is securely fastened to the power outlet and the display. <p>Note</p> <p>If the power cable is connected to a power bar, make sure the power bar is securely fastened to the power outlet and turned on.</p> <ul style="list-style-type: none"> • Make sure the power outlet is working by testing it with a different device. • Make sure the power cable is working by testing it with a different device.
The power light is lit, but the screen is blank.	<ul style="list-style-type: none"> • Press the Power button on the front of the display or on the remote control. • Restart the display. • Determine if the problem is with the video.

The screen is blank or there's a problem with the image on the screen

Symptom	Troubleshooting steps
<p>The screen is blank.</p>	<div style="display: flex; justify-content: space-between; margin-bottom: 10px;"> V4 V4 Pro V3 V3 Pro V2-C V2-C Pro V2 V2 Pro </div> <ul style="list-style-type: none"> • Press the Home button on the display or the remote control to open the Home screen. • Make sure the display is not in Standby mode by pressing the Power button . • Make sure any connected computers are on and not in an energy saving mode. • Restart the display and any connected computers. • Replace the video cables connecting any computers to the display to determine if the issue is with the cables. <div style="margin-top: 10px;"> MX </div> <ul style="list-style-type: none"> • Press Input  on the front control panel or the remote control, and then select OPS to switch to iQ and open the Home screen. • Make sure any connected computers are on and not in an energy saving mode. • Restart the display and any connected computers. • Replace the video cables connecting any computers to the display to determine if the issue is with the cables.
<p>A computer is connected to the display, but only a connection message appears on the screen.</p>	<ul style="list-style-type: none"> • Make sure the computer is connected to the currently selected input. • Make sure the display supports the connected computer's refresh rate. <i>See Setting a connected computer's resolution and refresh rate on page 45.</i> • If the currently selected input is a computer, make sure the computer is not in an energy saving mode.

Symptom	Troubleshooting steps
<p>The image on the screen is distorted. OR There are lines, snow, or other visual noise on the screen. OR The image is flickering or flashing. OR The image is dim.</p>	<div style="display: flex; justify-content: space-between; margin-bottom: 10px;"> V4 V4 Pro V3 V3 Pro V2-C V2-C Pro V2 V2 Pro </div> <ul style="list-style-type: none"> • Press the Home button on the display or the remote control. If the Home screen appears correctly, the issue is with the video input. • Switch to a different input and then back to the first input. • Make sure any connected computers are on and not in an energy savings mode. • Restart the display and any connected computers. • Set any connected computers' resolution and refresh rate to values that the display supports. <i>See Setting a connected computer's resolution and refresh rate on page 45.</i> • Replace the video cables that connect any computers to the display to determine if the issue is with the cables. Make sure a replacement cable meets the required specifications. <i>See Connecting room computers and guest laptops on page 38.</i> <div style="margin-top: 10px;"> MX </div> <ul style="list-style-type: none"> • Press Input  on the front control panel or the remote control, and then select OPS. If the Home screen appears correctly, the issue is with the video input. • Make sure the iQ appliance is securely installed in the accessory slot and its power light is on. • Switch to a different input and then back to the first input. • Make sure any connected computers are on and not in an energy savings mode. • Restart the display and any connected computers. • Set any connected computers' resolution and refresh rate to values that the display supports. <i>See Setting a connected computer's resolution and refresh rate on page 45.</i> • Replace the video cables that connect any computers to the display to determine if the issue is with the cables. Make sure a replacement cable meets the required specifications. <i>See Connecting room computers and guest laptops on page 38.</i>
<div style="display: flex; justify-content: space-between; margin-bottom: 10px;"> V4 V4 Pro V3 V3 Pro V2-C V2-C Pro </div> <p>There is no image when using the USB Type-C receptacle with a computer.</p>	<ul style="list-style-type: none"> • Make sure that the computer supports Display Port Alternate Mode video via USB Type-C. Look for the Display Port logo beside the USB Type-C receptacle on the computer. If it's not there, the computer may not support Display Port Alternate Mode video via USB Type-C. • Make sure the cable used with the USB Type-C receptacle supports Super Speed (5Gbps) USB. Look for the Super Speed USB logo on the cable. If the cable doesn't have the Super Speed USB logo, it may not have the internal wiring necessary to carry Display Port Alternate Mode video data.

Symptom	Troubleshooting steps
<p>There are bright spots on the screen.</p>	<div style="display: flex; align-items: center; margin-bottom: 10px;">         </div> <ul style="list-style-type: none"> • Press the Home button on the display or the remote control. If the Home screen appears correctly, the issue is with the video input. • Take a photograph of the screen and send it to SMART support. If SMART support determines that the issue is with the screen and the display is under warranty, you may be eligible for a replacement. <div style="margin-top: 10px;">  </div> <ul style="list-style-type: none"> • Press Input  on the front control panel or the remote control, and then select OPS. If the Home screen appears correctly, the issue is with the video input. • Take a photograph of the screen and send it to SMART support. If SMART support determines that the issue is with the screen and the display is under warranty, you may be eligible for a replacement.
<p>Colors don't appear correctly.</p>	<ul style="list-style-type: none"> • Be aware that if two or more displays are mounted side-by-side, there could be minor differences in colors across the displays. This issue is not unique to SMART products. • If the screen is completely lacking one color on the screen or the color problems occur on the Home screen, see <i>Contacting your reseller for additional support</i> on page 58. • If you're using a VGA video input, use a different cable or connect a different source to see if the issue is with the cable or input source. • Adjust the display's color settings, or reset them to the factory defaults.
<p>The image is cut off or shifted to the left or right.</p>	<ul style="list-style-type: none"> • Adjust any connected computers' video settings, particularly zoom, crop, and underscan. See the computer's operating system documentation. • If you're using a VGA video input and any connected computers' desktops are entirely black, change them to dark gray or a different color. • If any connected computers' desktops are extended across multiple screens, duplicate the desktops across the screens or set the display as the only screen.
<p>The image doesn't fill the entire screen.</p>	<ul style="list-style-type: none"> • Adjust any connected computers' video settings, particularly overscan. See the computer's operating system documentation. • Make sure the connected computer's video connector is configured to output a supported video signal. See the knowledge base article, No video display output from a laptop.
<p>A persistent image appears on the display.</p>	<p>See the knowledge base article, Image persistence or burn in on LCD displays.</p>

There's no sound or there's a problem with the sound

Symptom	Troubleshooting steps
<p>There's no sound. OR There is sound, but the volume is low. OR The sound is distorted or muffled.</p>	<ul style="list-style-type: none"> • If you're using an external audio system, make sure it is turned on. • Make sure the cables connecting the display to the computer are securely fastened. <div style="border-left: 2px solid #0070C0; padding-left: 10px; margin: 10px 0;"> <p>Notes</p> <ul style="list-style-type: none"> ◦ The display's stereo 3.5 mm in connector works with the VGA input only. ◦ Connecting an audio cable to the display's stereo 3.5 mm out connector disables the internal speakers. ◦ If you're using the display's S/PDIF out connector to connect a sound bar or receiver for external speakers, see the <i>SMART Board MX and MX Pro series interactive displays installation and maintenance guide</i> (smarttech.com/kb/171555). </div> <ul style="list-style-type: none"> • If you're using the display's stereo 3.5 mm out connector, adjust the volume on the display and the connected computer and make sure neither are muted. • If you're using the display's S/PDIF out connector, adjust the volume on the external audio system and make sure the audio system isn't muted. • Adjust the display's audio settings. • If you're using the integrated speakers, set the volume for the computer and any running applications to 80%, and then adjust the display's volume. <p>OR</p> <p>If you're using an external audio system, set the volume for the computer, any running applications and the display to 80%, and then adjust the external audio system's volume.</p>
<p>There is a whine or buzzing sound coming from the back of the display.</p>	<ul style="list-style-type: none"> • Be aware that these sounds are normal. All displays emit some electrical noise. Such sounds may be more noticeable with some displays than with others. However, if you hear noise from the front of the display, further investigation is required. • Connect all devices to the same power outlet or power bar.
<div style="display: flex; align-items: center;">  <p>The microphone array is not picking up sound.</p> </div>	<ul style="list-style-type: none"> • Ensure that the microphone array is enabled in the Settings menu. • If you're using an external computer, ensure that the computer's audio settings are configured to use the <i>SMART IFP Mic</i> as the input device.

Touch isn't working as expected

Symptom	Troubleshooting steps
<p>The display doesn't respond to touch.</p>	<ul style="list-style-type: none"> • Touch is not available immediately after waking or turning on the display. Wait a few seconds, and then the display will respond to touch. • Make sure the minimum required version of SMART Product Drivers (or later) is installed and running on connected computers (see page 58). • Make sure the USB cable between the display and the computer doesn't exceed the supported maximum cable length. • If a connected computer reports "Too many USB hubs" or "cannot start (code 10)," see the knowledge base article, SMART Board interactive displays and USB tier structure use. • Make sure any connected computers have detected the display's USB connection. • On Windows computers, open Device Manager and make sure there is no red X or yellow explanation mark (!) over the display's icon. • On Mac computers, open System Information and make sure there are no error messages in the display's row. • For Mac computers with macOS Mojave, see the knowledge base article, How to resolve issues with installing and using SMART Learning Suite software on macOS Mojave.
<p>The display responds to touch intermittently. OR When you touch the screen, the pointer doesn't appear in the correct place.</p>	<ul style="list-style-type: none"> • Make sure jewelry or clothing doesn't touch the screen when erasing ink. • When erasing, make sure your palm or fist is flat on the screen. • Touch is not available immediately after waking or turning on the display. Wait a few seconds, and then the display will respond to touch. • Restart the display. • Confirm with the installers that the computer is connected to the display with only a single cable. • Make sure SMART Product Drivers and Ink are installed and running on any connected computers, and orient the display. • Remove infrared sources, such as incandescent or arc lights, desk lamps, and infrared audio devices, or move the display to another location in the room. • Remove any USB extenders to help isolate the USB cable.

The pens and erasers aren't working as expected

Symptom	Troubleshooting steps
<p>The display doesn't respond to touch or writing with a pen.</p>	<ul style="list-style-type: none"> • Make sure the minimum required version of SMART Product Drivers (or later) is installed and running on connected computers (see page 58). • Touch is not available immediately after waking or turning on the display. Wait a few seconds, and then the display will respond to touch. • Make sure any connected computers have detected the display's USB connection. • On Windows computers, open Device Manager and make sure there is no red X or yellow explanation mark (!) over the display's icon. • On Mac computers, open System Information and make sure there are no error messages in the display's row. • Reinstall or update SMART Product Drivers and Ink on any connected computers.

Symptom	Troubleshooting steps
The display responds to touch but not to writing with a pen.	<ul style="list-style-type: none"> Reinstall or update SMART Product Drivers and Ink on any connected computers.
When you write on the screen, the ink appears in the wrong place. OR Writing is intermittent. OR Ink disappears as you write.	<ul style="list-style-type: none"> Make sure you are using a SMART Board MX or MX Pro series interactive display pen. See <i>SMART product pen comparison</i> (smarttech.com/kb/171230). Restart the display. Confirm with the installers that the computer is connected to the display with only a single cable. Clean the screen. If the ink appears in the wrong place on input from a connected computer, orient the display. Make sure SMART Product Drivers and Ink are installed and running on any connected computers. Make sure the pen nib is not worn. Replacement pens are available from the Store for SMART Parts (see smarttech.com/Support/PartsStore). Make sure SMART Product Drivers and Ink are installed and running on any connected computers, and orient the display. Remove infrared sources, such as incandescent or arc lights, desk lamps, and infrared audio devices, or move the display to another location in the room.
You can't write or draw in Microsoft Office.	<ul style="list-style-type: none"> Make sure Microsoft Office 2013 or later is installed. Reinstall or update <u>SMART Product Drivers and SMART Ink</u>.

NFC sign in isn't working as expected



Symptom	Troubleshooting steps
You're unable to sign in to your SMART Account using your SMART ID card.	<ul style="list-style-type: none"> Make sure NFC is enabled in settings. Set up your SMART ID card to use with your SMART Account. See <i>Setting up a SMART ID card</i> on page 27.
You're unable to use the display's NFC sign in feature with a connected computer.	<ul style="list-style-type: none"> Be aware that you cannot use your SMART ID card to sign in to connected computers. You can only use it to sign in to your SMART Account on iQ. Make sure the display's NFC sign in feature appears in the Device Manager (Windows operating systems) or Apple System Profiler (macOS operating system software). <p>Note</p> <p>The display's NFC sign in feature is a standard CCID smart card reader and can be used with smart cards and software that support CCID. SMART does not sell such products and does not provide support for them.</p>

iQ apps aren't working as expected

Symptom	Troubleshooting steps
iQ apps aren't working as expected.	See Troubleshooting iQ .

SMART software on connected computers isn't working as expected

Symptom	Troubleshooting steps
SMART Notebook software isn't working as expected.	See Troubleshooting SMART Notebook .
Lumio by SMART isn't working as expected.	See Troubleshooting common issues in Lumio by SMART .
SMART TeamWorks software isn't working as expected.	See Troubleshooting SMART TeamWorks .
SMART Meeting Pro software isn't working as expected.	See Basic troubleshooting for SMART Meeting Pro .
SMART Ink isn't working as expected.	See Troubleshooting SMART Ink .
SMART Product Drivers isn't working as expected.	See Troubleshooting SMART Product Drivers .

The SMART OPS PC module isn't working as expected



Symptom	Troubleshooting steps
The SMART OPS PC module isn't working as expected.	See the <i>SMART OPS PC modules user guide</i> (smarttech.com/kb/171747).

The Intel Compute Card isn't working as expected

Symptom	Troubleshooting steps
The Intel Compute Card isn't working as expected.	See Troubleshooting the iQ appliance (AM50) and Intel Compute Card .

Minimum required SMART Product Drivers versions

This table presents the minimum SMART Product Drivers versions for each model:

Models	Minimum version
	12.20
	12.18
	12.14

You can download SMART Product Drivers and Ink from smarttech.com/downloads.

Contacting your reseller for additional support

If an issue you're experiencing with the display persists or isn't covered in this chapter or the knowledge base, contact your authorized SMART reseller (smarttech.com/where) for support.

Your reseller might ask you for the display's serial number.



The serial number is on a label located on the left side of the display (pictured).

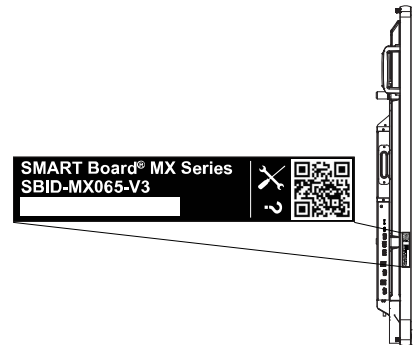

Tip

Scan the QR code on the label to view the SMART Board MX or MX Pro series interactive display support pages on the SMART website.



The serial number is on labels located on the bottom frame and the back of the display.

Note

To find the serial number for the iQ appliance and Intel Compute Card, see [Getting support and finding serial numbers for your iQ appliance and Intel Compute Card](#).

You can also find the serial number in the settings. Refer to the *SMART Board MX and MX Pro series interactive displays installation and maintenance guide* (smarttech.com/kb/171555) for more information.

Certification and compliance

Federal Communication Commission interference statement

FCC

Suppliers Declaration of Conformity

47 CFR § 2.1077 Compliance Information

Unique Identifier: IDX55-2, IDX55-3, IDX55-4, IDX65-1, IDX65-2, IDX65-3, IDX65-4, IDX75-1, IDX75-2, IDX75-3, IDX75-4, IDX86-1, IDX86-2, IDX86-3, IDX86-4

Responsible Party – U.S. Contact Information

SMART Technologies Inc.

2401 4th Ave., 3rd Floor

Seattle, WA 98121

compliance@smarttech.com

This device complies with Part 15 of the FCC Rules. Operation is subject to the following two conditions:

1. This device may not cause harmful interference, and
2. this device must accept any interference received, including interference that may cause undesired operation.

Note

This equipment has been tested and found to comply with the limits for a Class A digital device, pursuant to part 15 of the FCC Rules. These limits are designed to provide reasonable protection against harmful interference when the equipment is operated in a commercial environment. This equipment generates, uses, and can radiate radio frequency energy and, if not installed and used in accordance with the instruction manual, may cause harmful interference to radio communications. Operation of this equipment in a residential area is likely to cause harmful interference in which case the user will be required to correct the interference at his own expense.

⚠ Caution

Any changes or modifications not expressly approved by the party responsible for compliance could void the user's authority to operate this equipment.

Restriction

Operations in the 5.15–5.25GHz band are restricted to indoor usage only.

IEEE 802.11b or 802.11g operation of this product in the USA is firmware limited to channels 1 through 11.

⚠ Caution

- i. the device for operation in the band 5150–5250 MHz is only for indoor use to reduce the potential for harmful interference to co-channel mobile satellite systems;
- ii. the maximum antenna gain permitted for devices in the bands 5250–5350 MHz and 5470–5725 MHz shall comply with the e.i.r.p. limit; and
- iii. the maximum antenna gain permitted for devices in the band 5725–5825 MHz shall comply with the e.i.r.p. limits specified for point-to-point and non point-to-point operation as appropriate.
- iv. Users should also be advised that high-power radars are allocated as primary users (i.e., priority users) of the bands 5250–5350 MHz and 5650–5850 MHz and that these radars could cause interference and/or damage to LE-LAN devices.

Radiation exposure statement

This equipment complies with FCC radiation exposure limits set forth for an uncontrolled environment. This equipment should be installed and operated with minimum distance of 20 cm between the antenna of this device and all nearby persons. This transmitter must not be co-located or operated in conjunction with any other antenna or transmitter.

Innovation, Science and Economic Development Canada statement

This device complies with RSS-247 of the Innovation, Science and Economic Development Canada Rules. Operation is subject to the following two conditions:

1. This device may not cause harmful interference, and
2. this device must accept any interference received, including interference that may cause undesired operation.

Radiation exposure statement

This equipment complies with ISED radiation exposure limits set forth for an uncontrolled environment. This equipment should be installed and operated with minimum distance of 20 cm between the antenna of this device and all nearby persons. This transmitter must not be co-located or operated in conjunction with any other antenna or transmitter.

Innovation, Science et Développement économique Déclaration du Canada

Cet appareil est conforme à la norme ISED CNR-247 pour les appareils radio agréés. Son fonctionnement est soumis aux deux conditions suivantes:

1. le dispositif ne doit pas produire de brouillage préjudiciable, et
2. ce dispositif doit accepter tout brouillage reçu, y compris un brouillage susceptible de provoquer un fonctionnement indésirable.

Advertissement

- i. les dispositifs fonctionnant dans la bande 5 150-5 250 MHz sont réservés uniquement pour une utilisation à l'intérieur afin de réduire les risques de brouillage préjudiciable aux systèmes de satellites mobiles utilisant les mêmes canaux;
- ii. le gain maximal d'antenne permis pour les dispositifs utilisant les bandes 5 250-5 350 MHz et 5 470-5 725 MHz doit se conformer à la limite de p.i.r.e.;
- iii. le gain maximal d'antenne permis (pour les dispositifs utilisant la bande 5 725-5 825 MHz) doit se conformer à la limite de p.i.r.e. spécifiée pour l'exploitation point à point et non point à point, selon le cas.
- iv. De plus, les utilisateurs devraient aussi être avisés que les utilisateurs de radars de haute puissance sont désignés utilisateurs principaux (c.-à-d., qu'ils ont la priorité) pour les bandes 5 250-5 350 MHz et 5 650-5 850 MHz et que ces radars pourraient causer du brouillage et/ou des dommages aux dispositifs LAN-EL.

Déclaration d'exposition aux radiations

Cet équipement est conforme aux limites d'exposition aux rayonnements ISED établies pour un environnement non contrôlé. Cet équipement doit être installé et utilisé avec un minimum de 20 cm de distance entre la source de rayonnement et votre corps. Cet émetteur ne doit pas être co-implantés ou exploités conjointement avec une autre antenne ou émetteur.

EU declaration of conformity

Hereby SMART Technologies ULC declares that the radio equipment type Interactive displays model IDX55-2, IDX55-3, IDX55-4, IDX65-1, IDX65-2, IDX65-3, IDX65-4, IDX75-1, IDX75-2, IDX75-3, IDX75-4, IDX86-1, IDX86-2, IDX86-3, IDX86-4, and the OPS AM40, AM50, PCM8, PCM11 are in compliance with Directive 2014/53/EU.

Warning

Operation of this equipment in a residential environment this equipment may could cause radio interference.

The full text of the EU declaration of conformity is available at the following internet address: smarttech.com/compliance

The frequency band and the maximum transmitted power in EU are listed below:

Transmitting Band (MHz)	Maximum Transmit Power
IDX55-2, IDX55-3, IDX65-1, IDX65-2, IDX65-3, IDX75-1, IDX75-2, IDX75-3, IDX86-1, IDX86-2, IDX86-3	
2402-2483.5	19dBm (EIRP)
5150-5350	23dBm (EIRP)
5470-5350	23dBm (EIRP)
IDX55-4, IDX65-4, IDX65-4, IDX86-4	
13.56	0.0007μW (ERP)
2400-2483.5	20dBm (EIRP)
5150-5350	22dBm (EIRP)
5470-5725	20dBm (EIRP)
5725-5875	14dBm (EIRP)

Restrictions in

AT/BE/BG/CZ/DK/EE/FR/DE/IS/IE/IT/EL/ES/CY/LV/LI/LT/LU/HU/MTNL/NO/PL/PT/RO/SI/SK/TR/FI/SE/CH/UK/HR—5150MHz-5350MHz is for indoor use only.

Caution: Exposure to Radio Frequency Radiation

This equipment complies with EU radiation exposure limits set forth for an uncontrolled environment. This equipment should be installed and operated with minimum distance 20 cm between the radiator and your body.

SMART Technologies

smarttech.com/support

smarttech.com/contactsupport

smarttech.com/kb/171554